



Data Sheet Wöhr Slimparker 557 Tower

Suitable for condominium and office buildings.
For permanent use only!*

* In the event of frequently changing users (e.g. for office, hotel and business premises or similar) performance of constructive system configuration adaptations are necessary. Please note it is imperative that consultations are undertaken with WÖHR accordingly!

Slimparker 557 Tower-2,0: Load per parking pallet max. 2000 kg (load per wheel max. 500 kg).

Slimparker 557 Tower-2,6: Load per parking pallet max. 2600 kg (load per wheel max. 650 kg).



The facade design and the roofing structures can be individually customised. We would be happy to provide the relative consulting services.

Function

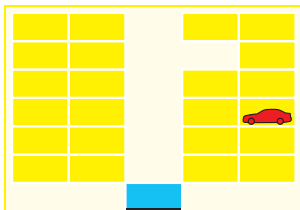

The red car is required.

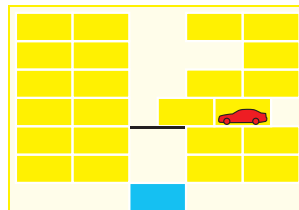

Both parking places are moved to the left.

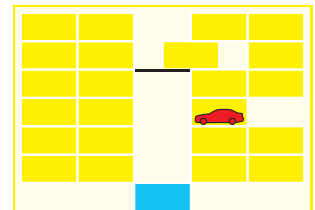

The vertical lift transports the first parking place upwards and moves it into an empty space.

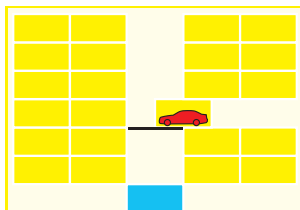

Now the vertical lift collects the red car ...

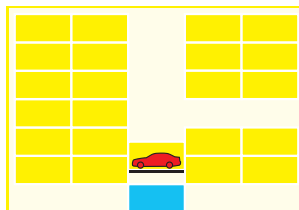

and transports it downwards to the transfer area.

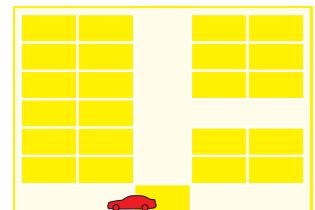

The red car is ready for exit.

Notes

- Measurements have to be clarified with WÖHR before starting the construction.
- It is necessary to consult with WÖHR as to the following points:
 - facades and roofing structures
 - roofing structure drainage system
 - parking pallet drainage system
 - roller shutters or sectional doors for the front and the rear ends of the car transfer section
 - onsite foundation works
- A parking pallet load of 2000 kg or 2600 kg to be the same for the overall system.
- For each system, it is possible to plan for up to two, different parking space heights.
- For double parking palette configurations it is always necessary to plan for an empty platform space. Said empty platform space must then be arranged into a parking level for the higher vehicle heights.
- The manufacturer reserves the right to construction or model modifications and/or alterations. Furthermore, the right to any subsequent part modification and/or variations and amendments in procedures and standards due to technical and engineering progresses in the art or due to environmental regulation changes, are also hereby reserved.



■ Dimensions

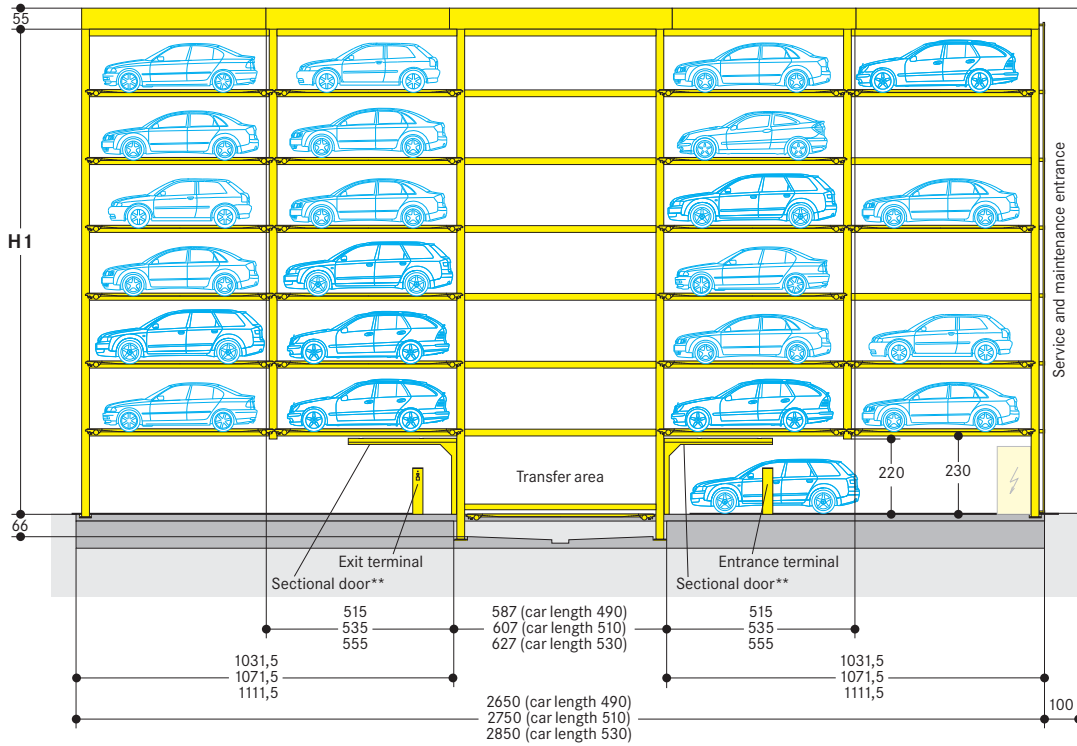

Transfer area and number of parking levels*	H1 for 150 cm car height	H1 for 160 cm car height	H1 for 170 cm car height	H1 for 180 cm car height	H1 for 190 cm car height	H1 for 200 cm car height
2	580	600	620	640	660	680
3	750	780	810	840	870	900
4	920	960	1000	1040	1080	1120
5	1090	1140	1190	1240	1290	1340
6	1260	1320	1380	1440	1500	1560

* In the event of vehicle heights other than those specified in the table, the system height dimensions will be altered accordingly.

** If roller shutters are installed, dimension H1 will be increased accordingly.

■ Ground view

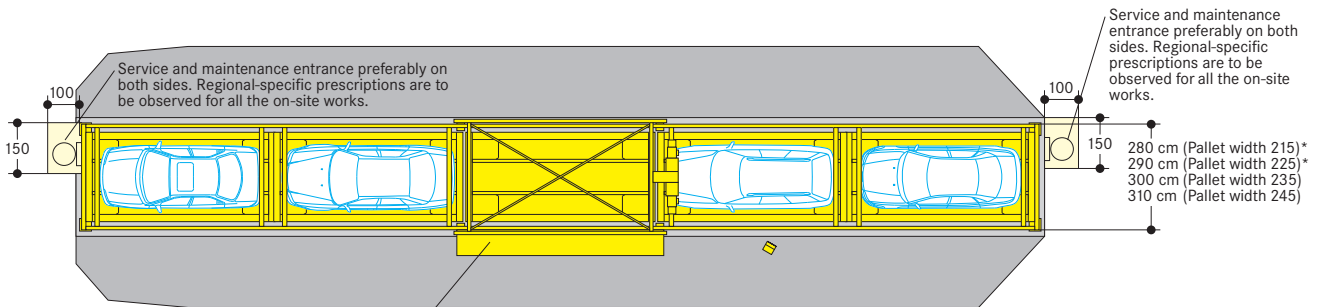

* In the event of parking pallet widths smaller than 235 cm, the wall facades in the drive-in areas need to be widened to ensure unilateral vehicle get-in and get-out by users.

If facades are added on, it is necessary to consider that an additional 5 to 10 cm need to be added onto the specified width dimensions.

■ Max. car dimensions

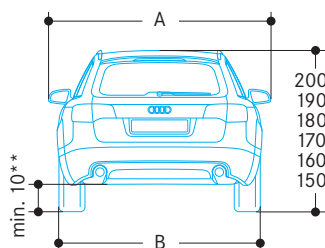
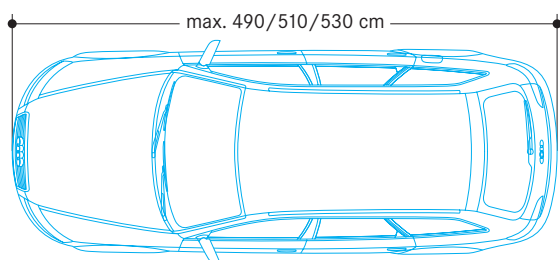

Pallet width	Dimension A	Dimension B
215	205	max. 190
225	215	max. 200
235	225	max. 210
245	235	max. 220

* Overall height (cars with roof racks, roof rails, antennas etc. should not exceed the mentioned overall height).

** Clearance underneath the gear case.

Optionally variable configuration of the entrance and exit areas, of the electric controls cabinet and of the service and maintenance entrance

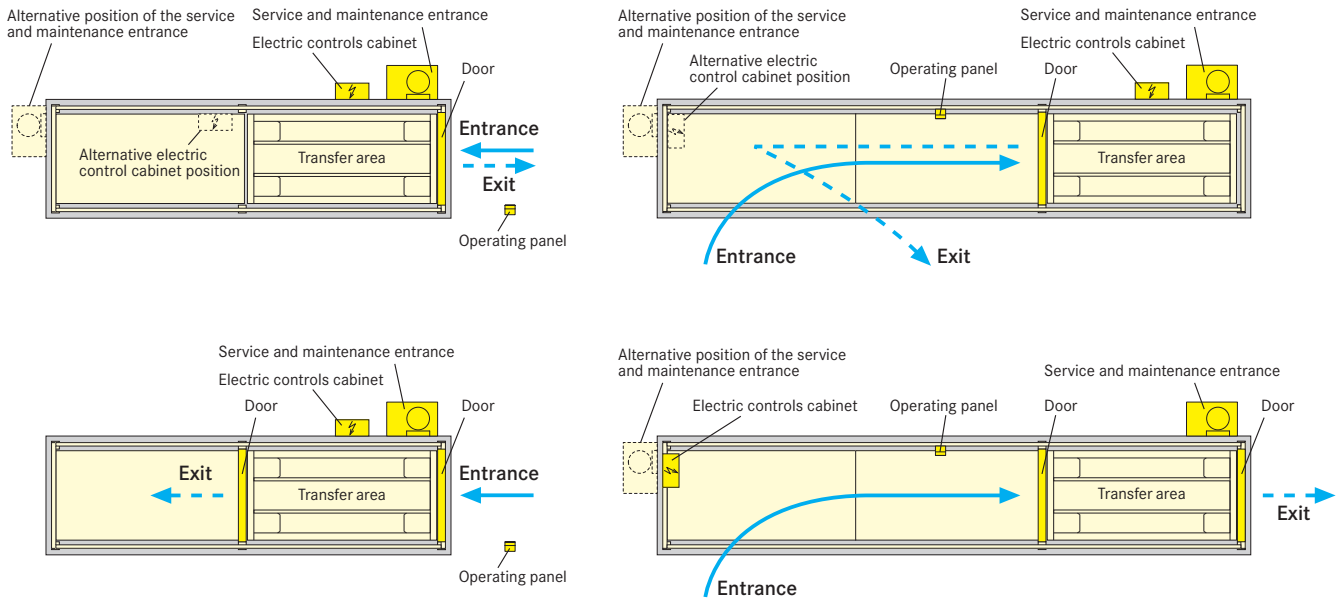

Possible arrangements

1 row

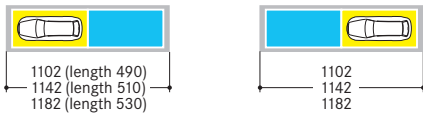

Parking levels	Parking places
2	2
3	3
4	4
5	5
6	6

2 rows

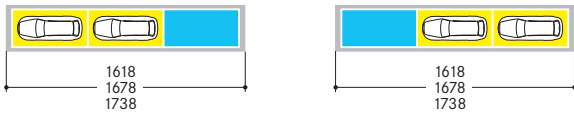

Parking levels	Parking places
2	3
3	5
4	7
5	9
6	11

2 rows (one in front and one behind the lift)

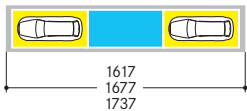

Parking levels	Parking places
2	4
3	6
4	8
5	10
6	12

3 rows

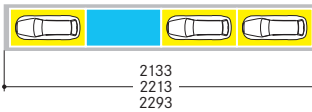
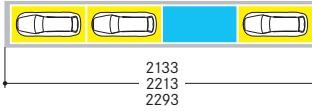

Parking levels	Parking places
2	5
3	8
4	11
5	14
6	17

4 rows

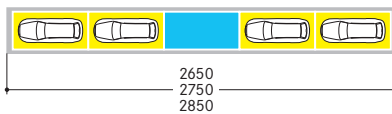

Parking levels	Parking places
2	7
3	11
4	15
5	19
6	23

Electrical data/switch cabinet

1. Main electrical supply 230/400V, 50Hz, 3 phase. Fuse or automatic circuitbreaker 3 x 40 A slow blow (acc. to DIN VDE 0100 p. 430).
2. In compliance with the DIN EN 60204 standard provisions, all systems must be connected directly on site with an earthed equipotential bonding. The lead-out connection must be at a 10 m distance!
3. For a remote maintenance (option) an internet connection to the switch cabinet is required.
4. Inside the maintenance shaft the space for the switch cabinet of 150 x 130 x 220 cm must be provided.
5. The control is designed to operate between +5° and +40°C. Atmospheric Humidity: 50% at +40°C. If the local circumstances differ from the above please contact Wöhr (if necessary, the switch cabinet has to be provided with a heating).

Grounding and potential equalisation

Customer has to provide a connecting outlet for grounding next to the control cabinet, because the Potential Equalisation Rail (PER) in the control cabinet has to be connected by a preferably short cable with the grounding outlet. In the area of the steel structure the customer has to provide at least every 10 to 20 meters (or in distances as required by the local lightning protection regulation) grounding outlets, because the total steel structure has to be connected with the grounding outlets by preferably short cables.

Operating device

1. Stand with an operating device for user guidance and multifunction button. Or alternatively to be attached to the building.
2. Parking system arrangement can be alternatively to the right or to the left side of the entrance (parking on both sides is optional). In the event of exit areas diagonally opposite to the relative entrance area, a second operating panel is installed at the exit area.

Operation

1. Automatic system operations as soon as the doors are completely closed and secured.
2. Selection of the parking slots via a transponder (remote system controls are also available on option).
3. Car monitoring (option): height, length and width as well as the position of the car could be checked with light barriers.
4. It is possible to integrate a traffic light or a barrier for the entrance or exit (option).

Noise protection

In compliance to the provisions set forth in the DIN 4109 »Noise abatement in above ground level buildings« standard provisions issued in November 1989, any devices, machinery and/or equipment installed into collectively-owned building facilities are to be provided with the necessary protection against the propagation of airborne and structure-borne noises. During night-time hours, the sound pressure level in living and sleeping quarters cannot be in excess of 30dB(A).

Airborne sound insulation:
Our standard configurations are compliant to the DIN 4109 standard

configurations, in as far as it is possible to establish that the building structure features a minimum airborne sound insulation index of R_w 57 dB (A).

Structure-borne sound insulation:
Wöhr offers additional measures for the reduction of structure-borne sound insulation. (In this connection, please send WÖHR in a specific request for a customised offer!)
WÖHR recommends a consultation between the sound insulation expert and WÖHR for the implementation of any possible additional measures for structure-borne sound insulation.

Temperature

The installation is designed to operate between +5° and +40°C. Atmospheric Humidity: 50% at +40°C. If the local circumstances differ from the above please contact WÖHR.

Conformity test

All our systems are checked according to EC machinery directive 2006/42/EC and EN 14010.

Drainage (to be performed by the customer)

WÖHR recommends providing gutter in the pit centre and connecting the gutter either to a gully or a drainage pit. If the pump sump is not accessible for manual drainage, the client must provide a pump on site to empty the pump sump.

To prevent hazards for the ground water, WÖHR recommends giving the pit floor an oil-resistant coating as a means of protecting the environment.
If this is to be connected to the sewage system, it is advisable to provide oil and/or petrol separators.

Ventilation (to be performed by the customer)

It is necessary to see to sufficient overall ventilation for the necessary exchange of fresh air, for the reduction of system humidity, the prevention of ambient condensation and dissipation of vehicle moisture (due to rain, snow, ice and the likes).

Lighting (to be performed by the customer)

In the transfer area at least 500 lux, see EN 1837:1999.
In the system area at least 50 lux, see EN 81-1:1998.

Fire protection (to be performed by the customer)

Preventive fire protection measures should be discussed between the architect and the building authority and/or the preventive fire protection authority.

Maintenance entrance

To the purpose of system maintenance it is necessary to provide on-site for a system maintenance entrance, via which it can be possible to access all the parking levels by means of stairs and/or ladders.

Statics and construction

Structural steelwork:

The structural steelwork serves as a construction frame incorporating the transfer and carriage units and the parking pallets. It is locked down to the foundation works and is supported by the relative side walls. This requires at least a C25/30 concrete quality grade. The structural statics for the project in question can be supplied by WÖHR.

Roofing and facades:

Outdoor system installations require both roofing and at least a partially closed-off facade. Execution works/structural statics and further, detailed information and data depends on the project in question. Detailed information can be provided subsequent to prior agreements to be taken accordingly.

Additional loads:

For standard systems, the following additional structural static loads are to be taken into account:

Facade loads:

max. 0,5 kN/m² (locating point – load application to be possibly in the vicinity of the corner connection joints between the cross beams and the perpendicular pillars).

Roof loads:

Roofing to be approx. 0,5 kN/m².

Snow loads:

max. 1,6 kN/m².

Wind loads:

max. 1,0 kN/m².

Seismological loads:

based on earthquake zone 1 in Germany (EMS seismic intensity scale values 6.5 > 7) as affected by the DIN 4149:2005-04 or latest standard provisions (and consequently the rated ground acceleration value: a_g = 0.4/s²)

Verifiable structural statics for all the specified loads are available upon request.

Dimensions

All dimensions shown are minimum. Construction tolerances must be taken into consideration. All dimensions in cm.