



# Data Sheet Wöhr Combilift 542-2,0

Suitable for condominium and office buildings.  
For permanent use only!\*

\* In case of short time user (e.g. for offices, hotels, a.s.o.) technical adjustments are required. Please contact WÖHR!

Platforms are in horizontal position to drive on.

**Load per platform max. 2000 kg (load per wheel max. 500 kg)**

Special reinforced units for higher parking platform load are available (see 542-2,6).

**X** = Door offset (see page 2 for details)

Dimensions

\* in this zone, 0% of downward/upward slope in longitudinal and cross direction

\*\* see notes, point 5

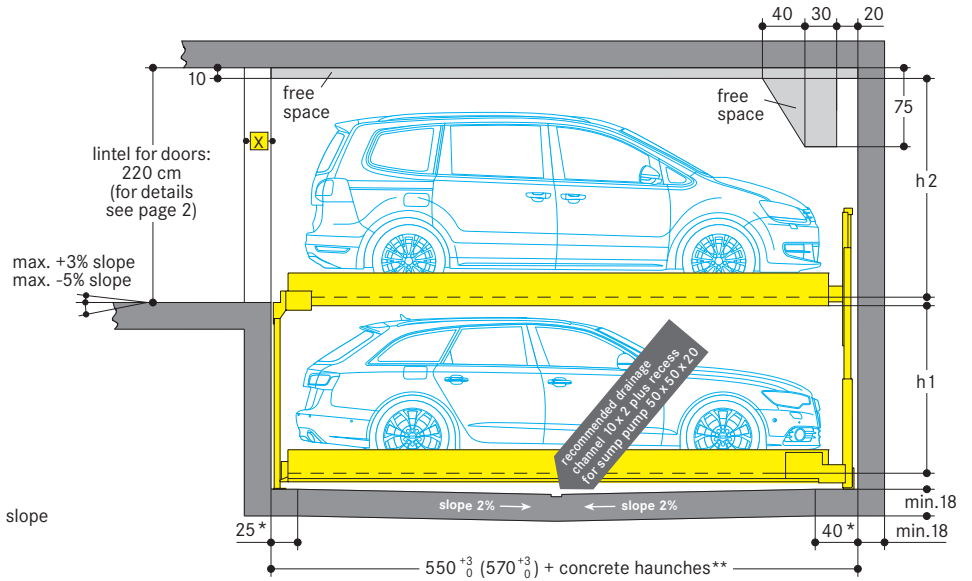

## Comfort type 542 · 2000 kg

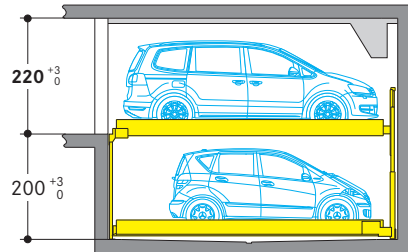

	car height	distance
<b>EL</b>	Cars/Vans up to 200 cm and 2000 kg max.	h2 = 205
<b>LL</b>	Cars/Station wagons up to 175 cm	h1 = 180

EL = entrance level, LL = lower level

## Compact type 542 · 2000 kg

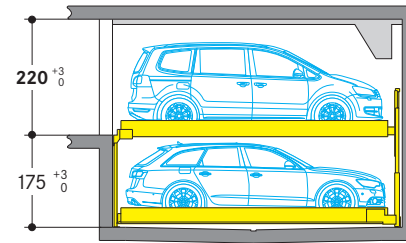

	car height	distance
<b>EL</b>	Cars/Vans up to 200 cm and 2000 kg max.	h2 = 205
<b>LL</b>	Cars/Station wagons up to 150 cm	h1 = 155

Please attend to restricted car heights on lower platforms!

## Width dimensions

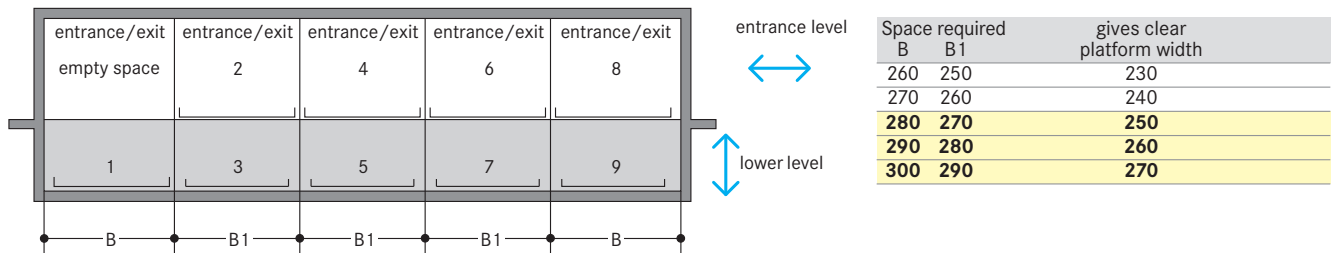

One entry/exit is required on entrance level for each grid.

## Notes

- Pits must always be protected by a sliding shutterdoor (even in underground garages).
- Arrangements start with 2 grids for 3 cars, 3 grids for 5 cars.
- Installation length of 550 cm for car length of a max. of 500 cm. Clear platform width of 250 cm for car widths of 190 cm. For large touring sedans we recommend a clear platform width of at least 260-270 cm.
- For large touring sedans an installation length of 570 cm is recommended. This length offers larger safety distances for potential future developments or projects with short term parkers such as hotels or similar.
- It is not possible to have channels or undercuts and/or concrete haunches along the pit's rear and front floor-to-wall joints. In the event that channels or undercuts are necessary, the pit length needs to be increased based on the dimensions of said channels or undercuts.
- The manufacturer reserves the right to construction or model modifications and/or alterations. Furthermore, the right to any subsequent part modification and/or variations and amendments in procedures and standards due to technical and engineering progresses in the art or due to environmental regulation changes, are also hereby reserved.

Combilift 542-2,0 | 05.2016 | C027-5179 | © Otto Wöhr GmbH

## Doors

According EN 14010, the Combilift 542 must be closed with shutterdoors. The door controls are integrated in the overall system. That means:

- The doors are electro-mechanically interlocked.
- The doors can only be opened when the selected parking place has reached the entry/exit position.
- Any pits are closed in the entrance area.

Local requirements for electrical doors regarding the technology, maintenance and revision are not subject of our delivery. These matters have to be observed and carried out by the customer, according to the local regulations.

### Door types:

Manually operated sliding shutterdoors

- for underground garages with galvanised barred metal panelling
- above ground with powder coated metal sheets (RAL 7030)

Alternatively, sliding shutterdoors can be supplied with electrical drive.

### Installation:

Behind the building pillars with door offset

### Section

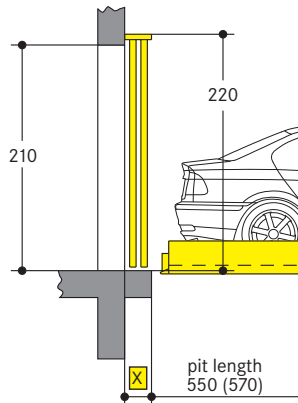

- X = 25 cm for manually operated sliding shutterdoors
- X = 35 cm for automatic shutterdoors

### Ground plan

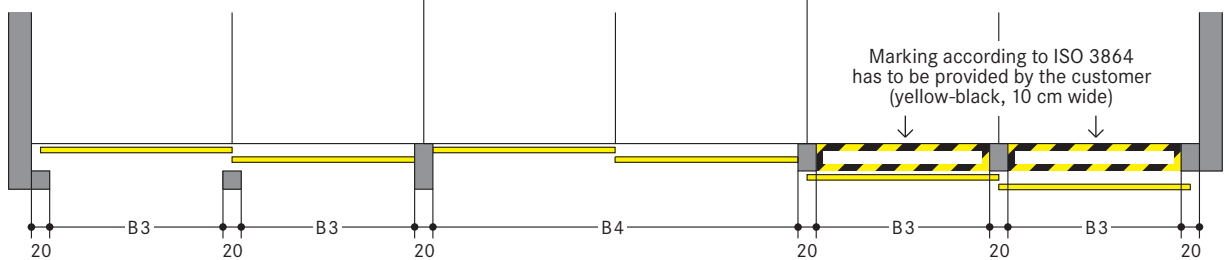

Space required	Gives clear platform width	
B3	B4	
230	480	230
240	500	240
<b>250</b>	<b>520</b>	<b>250</b>
<b>260</b>	<b>540</b>	<b>260</b>
<b>270</b>	<b>560</b>	<b>270</b>

\* The lintel of 220 cm is absolutely necessary. With differing heights, additional fixings are required at a surcharge. If no lintel is provided, the gates need to be fitted onto a steel frame (subject to surcharges).

### Installation:

Below the lintel between the building pillars

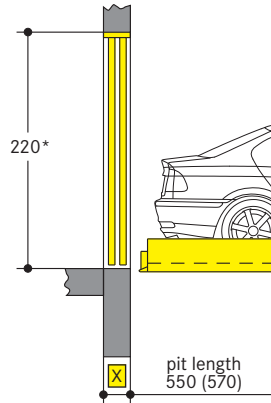

### Installation:

In front of the building pillars

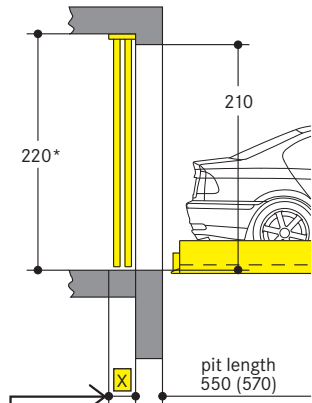

With installation in front of the pillars, the driving aisle is measured from the door.

## Sliding door floor guides in underground garages

The evenness or flatness of the floor in the bottom floor guide section is required to comply with the DIN 18202, Table 3, line 3, standard requirements.

The bottom floor guides are constituted by plastic rollers, locked down onto floor mounted base plates.

Dowel borehole depth to be approx. 9 cm.

Note: In the event that floor filling needs to be laid into the door section to the purpose of reaching the required floor evenness, the borehole depth needs to be increased by the thickness of the floor fill (for a max of 4 cm).

### Front view

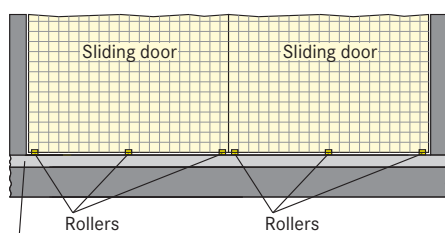

Finished floor level compliant to DIN 18353, floor evenness compliant to DIN 18202 table 3, line 3.

Locking down of the rollers onto the base plate by means of an adhesive anchor with an M8 internal screw thread.

### Section

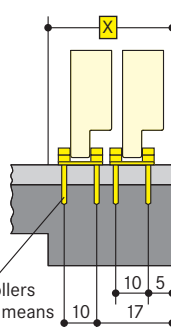

## Sliding door floor guides in above ground garages

The evenness or flatness of the floor in the bottom floor guide section is required to comply with the DIN 18202, Table 3, line 3, standard requirements.

The bottom floor guides are constituted by guide rails, locked down onto the floor.

Dowel borehole depth to be approx. 8 cm.

Note: In the event that floor filling needs to be laid into the door section to the purpose of reaching the required floor evenness, the borehole depth needs to be increased by the thickness of the floor fill (for a max of 4 cm).

### Front view

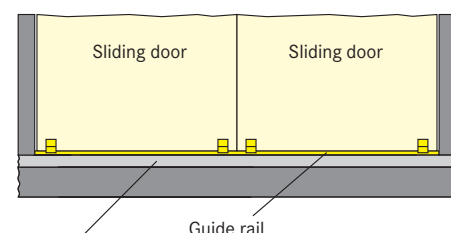

Finished floor level compliant to DIN 18353, floor evenness compliant to DIN 18202 table 3, line 3.

Guide rails to be fixed on using S 10 hexagon head wood bolts and plastic expansion dowels.

### Section

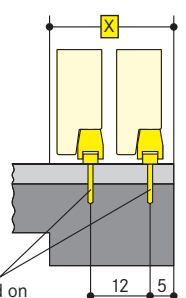

## Width dimensions and statics

All dimensions shown are minimum. Constructional tolerances must be taken into consideration. All dimensions in cm.

Section

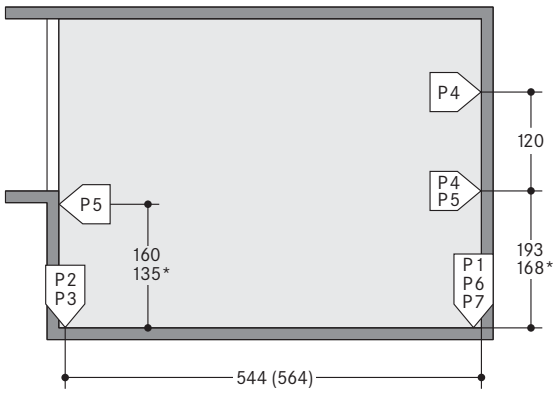

( ) dimensions in brackets for longer units  
\* dimensions for compact type

P1 = +42,0 kN<sup>1)</sup>  
P2 = +29,0 kN  
P3 = +15,0 kN  
P4 = ± 5,0 kN  
P5 = ± 2,5 kN  
P6 = ±15,0 kN  
P7 = ± 8,0 kN

<sup>1)</sup> all static loadings include the weight of the car

Bearing loads are transmitted by wall plates with min. 30 cm<sup>2</sup> surface and to the floor by base plates with min. 350 cm<sup>2</sup> surface.

Wall and base plates to be fixed by heavy duty anchor bolts to a drilling depth of 10-12 cm. When fixing to the waterproof concrete floors chemical anchors are employed (to be advised by WÖHR).

Base plate thickness min. 18 cm. Rear wall and base plate must be formed of concrete and must have a flat surface without protrusions.

Concrete quality according to the static building requirements, however for the dowel fixing concrete quality of min. C20/25 is required.

The specified lengths to the support points are mean values. Please contact WÖHR Agent for exact positions for any variations on the standard units.

Please contact WÖHR Agent for clarify the door widths/widths of columns. Grid width of 250/260/270/280/290 cm must be observed.

Ground plan

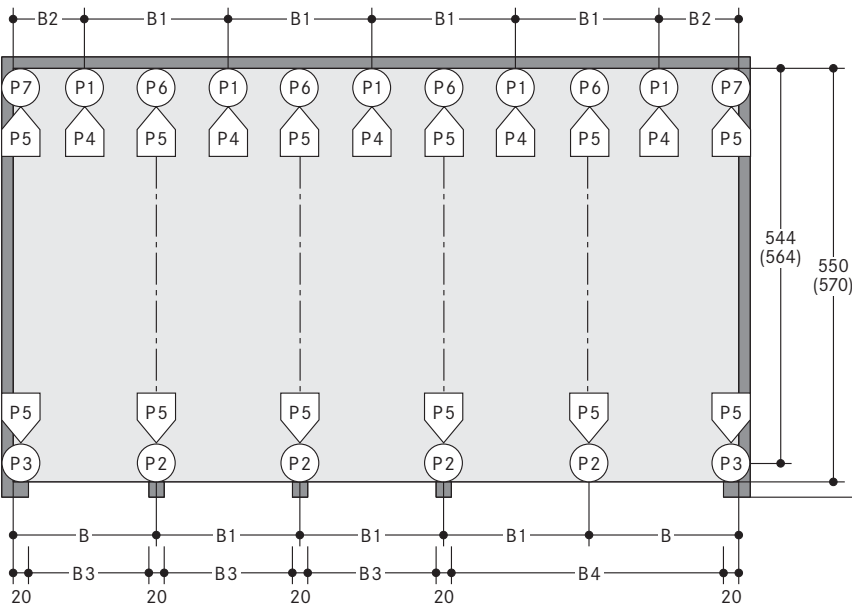

↑  
The driving aisle width to be compliant with country regulations locally in force.

Space required					gives clear platform width
B	B1	B2	B3	B4	
260	250	135	230	480	230
270	260	140	240	500	240
280	270	145	250	520	250
290	280	150	260	540	260
300	290	155	270	560	270

### Notice:

If the width of the pillars is more than 20 cm, than the width of the drive through will be reduced accordingly to the above mentioned width dimensions. In order to avoid this, we recommend to extend the measures between the pillars (B3 and B4) accordingly. Please contact WÖHR.

## Hydraulic power packs

For the accommodation of the hydraulic power packs an additional space is required which will be determined during the verifications of the drawings,

e.g. in a wall recess.  
Dimensions:  
length = 100 cm  
height = 140 cm  
depth = 35 cm

## Electrical data

Circuit connections 230/400V, 50 Hz, 3 phases. Max power consumption 1.5/3.0 kW. Circuit breaker or 3 x 16A time-lag fuse automatic circuit breaker unit (compliant to the DIN VDE 0100 standard requirements) and a 3 phase + N + PE feed cable, compliant to the prescriptions set forth by the local facilities supply company up to the electric

controls cabinet, further to the installation of the feed cables into the electric controls cabinet, to be performed basically on-site. In compliance with the DIN EN 60204 standard provisions, all systems must be connected directly on site with an earthed equipotential bonding. The lead-out connection must be at a 10 m distance!

## Switch cabinet

1. Main switch is installed well accessible at driveway in a height of 160 cm to 190 cm.
2. The switch cabinet must be installed visible and near by the system. Area for installation has to be provided by the customer. The size of the switch cabinet is 80 x 110 x 21 cm.
3. The wall opening of 15 cm diameter is required between the switch cabinet and the system itself. Please contact WÖHR Agent to clarify.
4. The control is designed to operate between +5° and +40°C. Atmospheric Humidity: 50% at +40°C. If the local circumstances differ from the above please contact WÖHR (if necessary, the switch cabinet has to be provided with a heating).
5. If the system is installed outside the switch cabinet needs to be inside a sun-/water-/wind proof box. In front of the switch cabinet an area of 100 cm is required to work.

## General product information

The entrance level parking place row has one place less than the lower level. This empty space always stays on entrance floor level. The platforms at the entrance floor level are shifted sideways by one

space so that the empty space is above the lower level platform to be raised. This movement is initiated automatically when the desired place is selected via keyboard.

## Hotel garage

If used by hotel guests, the installation requires special planning and construction. Please ask for details.

## Noise protection

Basis is the German DIN 4109 "Noise protection in buildings".

With the following conditions required 30 dB (A) in rooms can be provided:

- noise protection package from our accessory
- insulation figure of the construction of min.  $R_w = 57$  dB
- walls which are bordering the parking systems must be done as single wall and deflection resistant with min.  $m^2 = 300$  kg/m<sup>2</sup>
- solid ceiling above the parking systems with min.  $m^2 = 400$  kg/m<sup>2</sup>

At differing constructional conditions additional sound absorbing measures are necessary.

The best results are reached by separated sole plates from the construction.

### Increased noise protection:

If increased noise protection must be provided planning has to be confirmed on a project basis by WÖHR.

## Temperature

The installation is designed to operate between +5° and +40°C. Atmospheric Humidity: 50% at +40°C. If the local circumstances differ from the above please contact WÖHR.

## Conformity test

All our systems are checked according to EC machinery directive 2006/42/EC and EN 14010.

## Illumination

Illumination has to be considered acc. to local requirements by the customer.

## Numbering of the parking spaces

1. The empty space of the Combilift is always on the left in the entrance level.

2. The numbering is as follows:

EG	2	4	6	8
UG	1	3	5	7

3. The numbering for each system starts with 1 as above.

4. Different numbering of parking spaces is possible at a surcharge (software changes are necessary).

## Free spaces

Special drawings for free spaces to accommodate air ducts or other pipes can be requested at WÖHR Agent!

## Railings

If walkways are arranged directly to the side or behind the systems, railings have to be provided by the customer acc. to local requirements, height min. 200 cm – this is applicable during the construction phase too.

## Drainage

We recommend providing gutter in the pit centre and connecting the gutter either to a gully or a drainage pit 50 x 50 x 20 cm. If the pump sump is not accessible for manual drainage, the client must provide a pump on site to empty the pump sump. Lateral slope only within the gutter.

To prevent hazards for the ground water, we recommend giving the pit floor an oil-resistant coating as a means of protecting the environment.

If this is to be connected to the sewage system, it is advisable to provide oil and/or petrol separators.

## Maintenance

WÖHR and its foreign partners have an assembly and customer network. Annual maintenance is performed at conclusion of a maintenance contract.

## Protection against corrosion

Independent of a maintenance workings has to be carried out acc. to WÖHR Cleaning and Maintenance Instruction regularly.

Clean up galvanized parts and platforms of dirt and road salt as well as other pollution (corrosion danger)!

Pit must always be ventilated and deaerated well.

## Parking place width

We recommend a clear platform width of at least 250 cm.

## Dimensions

All dimensions shown are minimum. Construction tolerances must be taken into consideration. All dimensions in cm.

## Fire safety

Each and every fire safety requirement and all possible mandatory item(s) and equipment(s) (fire extinguishing systems and fire alarm systems, etc.) are to be provided by the customer.

## Clearance profile (standard saloon/estate car)

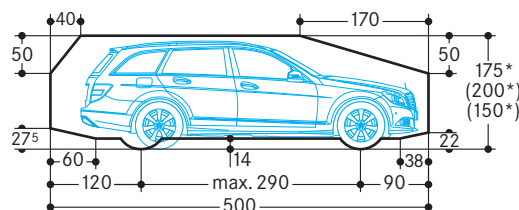

\* The total car height includes roof rail and antenna fixture and must not exceed the mentioned max. height dimension.

## Notes

We recommend providing wiring conduits leading to operating panels, particularly in above-ground garages.

The wiring conduits should be placed 120 cm above entrance level in a support in the middle of the area.